



## Cube 22" Single

Model Code: CRC508

### Included Accessories

		
UMD	WK-06-40 CUPC	CARE KIT

### Optional Accessories

		
DGC-508	CBB-1416C	COC-20
		
DTC-18	ASC406	DRC007

### Dimensions

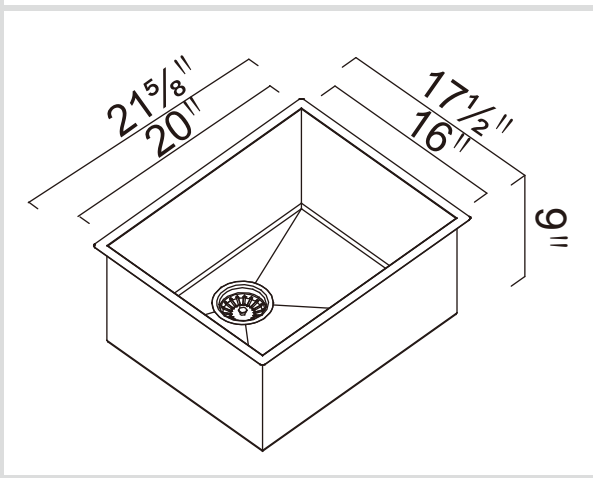

### Specifications

Description	Single bowl, Sink
Overall Sink Size	21 5/8" x 17 1/2" x 9" deep
Bowl Dimensions	20" x 16" x 9" deep
Installation	Undermount
Thickness	18 ga
Material	Stainless steel SUS304

### Installation



Fixings	Undermount clips supplied
Template	CAD on request
Min Cabinet Size	24"
Waste Holes	1 x 3 1/2" round Compatible with waste disposal
Sealing Strip	N/A



### Plumbing

Waste Fittings	1 x (3 1/2" x 1 1/2") basket waste included
----------------	---

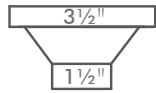
### Packaging

Carton Type	EPS protection & Carton
Gross Weight	28.93Lbs
Carton Size	23 5/8" x 19 7/8" x 17 3/4"
Package	1

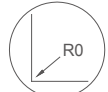
<b>SURFACE FINISH</b>  Microbrush	<b>WASTE KIT</b> 	<b>MATERIAL</b>  Stainless Steel
--	---	---

<b>INSTALLATION OPTIONS</b>  Undermount	<b>PROFILE</b>  R0 Vert  R6 Horiz
--	--

Limited 25 year Warranty: Zomodo Stainless Steel Sinks; Décor Living Innovations Inc. hereafter referred to as Décor, is pleased to offer a limited 25 year warranty with all Zomodo sinks used in normal domestic installations. Décor warrants its sinks to be free from all manufacturing defects in material and workmanship. Décor will repair or replace (at Décor's discretion), at no charge, excluding labour, any sink supplied by Décor that is proven to be defective under normal use. Please visit [www.decor.ca](http://www.decor.ca) to see full Terms & Conditions.

Zomodo Product Certification: All Zomodo pressed sinks and waste kits sold in Canada are CSA approved. All Zomodo sinks are tested and exceed the requirements of CSA standard ASME A112.19.3-2008/CSA B45.4-08 - Stainless steel plumbing fixtures. Our Waste kits are tested and exceed the requirements of cUPC Standard. Our faucets are tested and exceed both cUPC and CSA standards.