

Cayman PearlArc

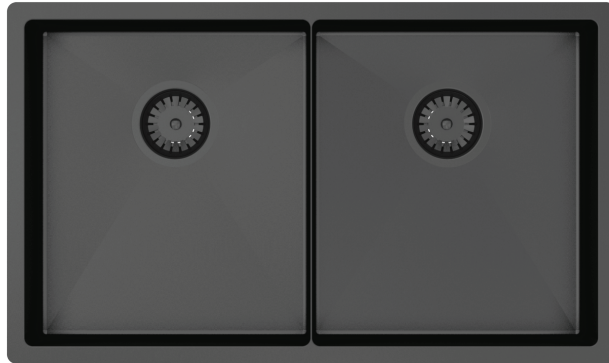

*Currently not available in Canada



*Currently not available in Canada

Cayman 34.5" Double 50/50

Model Code: CAC406D3-BK/EG/RB

Included Accessories

 UMG	 WK-06-40-BK/EG/RB	 DGC406-BK/EG/RB x 2
 CARE KIT	 WK-ODC-BK/EG/RB	

Optional Accessories

 DTC-18-BK/EG/RB	 CBF250C	 COC-20-BK/EG/RG

Dimensions

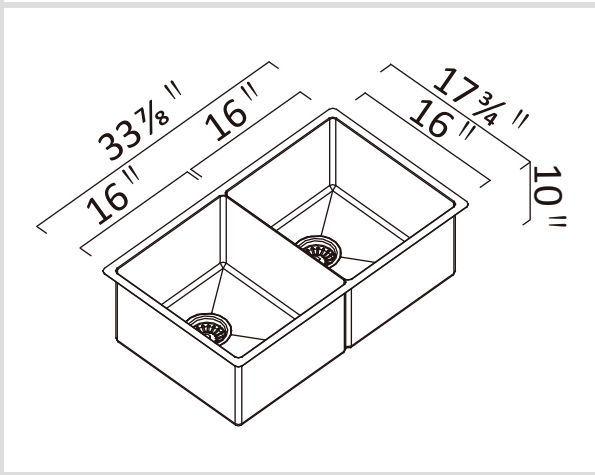

Specifications

Description	Pearl Arc Double Bowl Sink
Overall Sink Size	33 7/8" x 17 3/4" x 10" deep
Bowl Dimensions	16" x 16" x 10" deep 16" x 16" x 10" deep
Installation	Undermount
Material	16 ga SUS304 Stainless Steel
Colour/Finish	Black (BK), Gold (EG), Bronze (RB)

Installation



Fixings	Undermount clips supplied
Template	zomodo.ca/product/cac406d3-bk
Min Cabinet Size	36"
Waste Holes	2 x 3 1/2" round Compatible with waste disposal
Sealing Strip	N/A



Plumbing

Waste Fittings	2 x (3 1/2" x 1 1/2") basket waste included
----------------	---

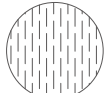
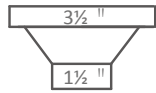
Packaging

Carton Type	Single Carton
Gross Weight	27 lbs
Carton Size	37 1/8" x 12 5/8" x 20 1/4"

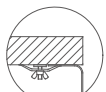
SURFACE FINISH  PearlArc	WASTE KIT 	MATERIAL  Stainless Steel
--	---	---

INSTALLATION OPTIONS  Undermount	PROFILE  Corner
--	---

Limited 25 year Warranty: Zomodo Stainless Steel Sinks: Décor Living Innovations Inc. hereafter referred to as Décor, is pleased to offer a limited 25 year warranty with all Zomodo sinks used in normal domestic installations. Décor warrants its sinks to be free from all manufacturing defects in material and workmanship. Décor will repair or replace (at Décor's discretion), at no charge, excluding labour, any sink supplied by Décor that is proven to be defective under normal use. Please visit www.decor.ca to see Full Terms & Conditions.

Zomodo Product Certification: All Zomodo pressed sinks and waste kits sold in Canada are CSA approved. All Zomodo sinks are tested and exceed the requirements of CSA standard ASME A112.19.3-2008/CSA B45.4-08 - Stainless steel plumbing fixtures. Our Waste kits are tested and exceed the requirements of cUPC Standard. Our faucets are tested and exceed both cUPC and CSA standards.