

## MOC406D (Sink ONLY)

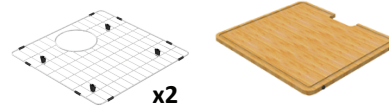

## MOC406D-K1 (Standard Kit)



## MOC406D-K2 (Deluxe Kit)

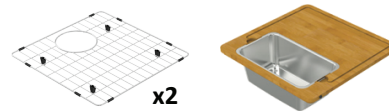

## Montego 34" Double 50/50

## Model Code: MOC406D

### Included Accessories



### Optional Accessories



### Dimensions

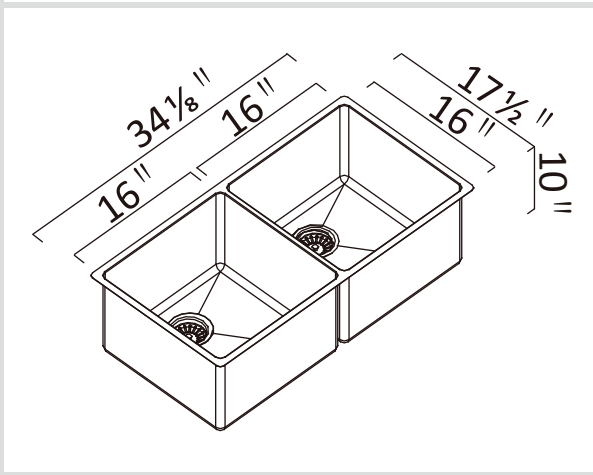

### Specifications

Description	Double bowl, Sink
Overall Sink Size	34 7/8" x 17 1/2" x 10" deep
Bowl Dimensions	16" x 16" x 10" deep 16" x 16" x 10" deep
Installation	Undermount
Thickness	18 ga
Material	Stainless steel SUS304

### Installation



Fixings	Undermount clips supplied
Template	<a href="http://zomodo.ca/product/moc406d">zomodo.ca/product/moc406d</a>
Min Cabinet Size	36"
Waste Holes	2 x 3 1/2" round Compatible with waste disposal
Sealing Strip	N/A



### Plumbing

Waste Fittings	2 x (3 1/2" x 1 1/2") basket waste included
----------------	---

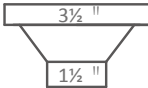
### Packaging

Carton Type	Single Carton
Gross Weight	27 lbs
Carton Size	37 3/4" x 12 1/2" x 20 1/2"

<b>SURFACE FINISH</b>  Microbrush	<b>WASTE KIT</b>  3 1/2" 1 1/2"	<b>MATERIAL</b>  SUS 304 Stainless Steel
--	---	--

<b>INSTALLATION OPTIONS</b>  Undermount	<b>PROFILE</b>  R15 Corner
--	--

Limited 25 year Warranty: Zomodo Stainless Steel Sinks: Décor Living Innovations Inc. hereafter referred to as Décor, is pleased to offer a limited 25 year warranty with all Zomodo sinks used in normal domestic installations. Décor warrants its sinks to be free from all manufacturing defects in material and workmanship. Décor will repair or replace (at Décor's discretion), at no charge, excluding labour, any sink supplied by Décor that is proven to be defective under normal use. Please visit [www.decor.ca](http://www.decor.ca) to see full Terms & Conditions.

Zomodo Product Certification: All Zomodo pressed sinks and waste kits sold in Canada are CSA approved. All Zomodo sinks are tested and exceed the requirements of CSA standard ASME A112.19.3-2008/CSA B45.4-08 - Stainless steel plumbing fixtures. Our Waste kits are tested and exceed the requirements of cUPC Standard. Our faucets are tested and exceed both cUPC and CSA standards.