

#### Features

- Pressure-balancing diaphragm technology maintains outlet temperature within +/-3 degrees Fahrenheit during water pressure fluctuations.
- Provides temperature regulation and automatic anti-scald protection.
- Single handle controls both on/off activation and temperature settings.
- Includes faceplate with ADA-compliant metal lever handle.
- Includes single-function 1.75 gpm (6.6 lpm) showerhead.
- Showerhead features MasterClean™ sprayface for easy cleaning.
- Coordinates with Purist® faucets and accessories.

#### Material

- Premium material construction with metal handle ensures reliability and durability.
- KOHLER finishes resist corrosion and tarnishing.

#### Installation

- Trim set requires valve to complete installation (sold separately).

#### Required Products/Accessories

K-304/K-P304 Series Rite-Temp® Valves

or

K-8304/K-P8304 Series Rite-Temp® Valve & Cartridge Kits

or

K-8300/K-P8300 Series Rite-Temp® Valve Body Rough-ins

K-8305/K-P8305 Series Rite-Temp® Cartridges

or

K-2971-KS 3/4" Pressure-balancing Valve

#### Adapters, Rough-in and Extension Kits

1016154 Range: 3-1/2" (89 mm) - 4-1/2" (114 mm)

#### Optional Products/Accessories

K-10350 Deep Rough-In Kit For K-8305 Cartridges

K-10351 Test Cap For K-8300 Series Valve Bodies

88526 Thin Wall Trim Kit

#### Included Components

Additional Components:

Shower arm and flange



#### Codes/Standards

ASME A112.18.1/CSA B125.1

DOE - Energy Policy Act 1992

EPA WaterSense®







California Energy Commission (CEC)

#### KOHLER® Faucet Lifetime Limited Warranty

See website for detailed warranty information.

#### Available Colors/Finishes

*Color tiles intended for reference only.*

Color	Code	Description
	CP	Polished Chrome
	SN	Vibrant® Polished Nickel
	BGD	Vibrant® Moderne Brushed Gold
	BN	Vibrant® Brushed Nickel
	BV	Vibrant® Brushed Bronze
	BL	Matte Black
	RGD	Vibrant Rose Gold

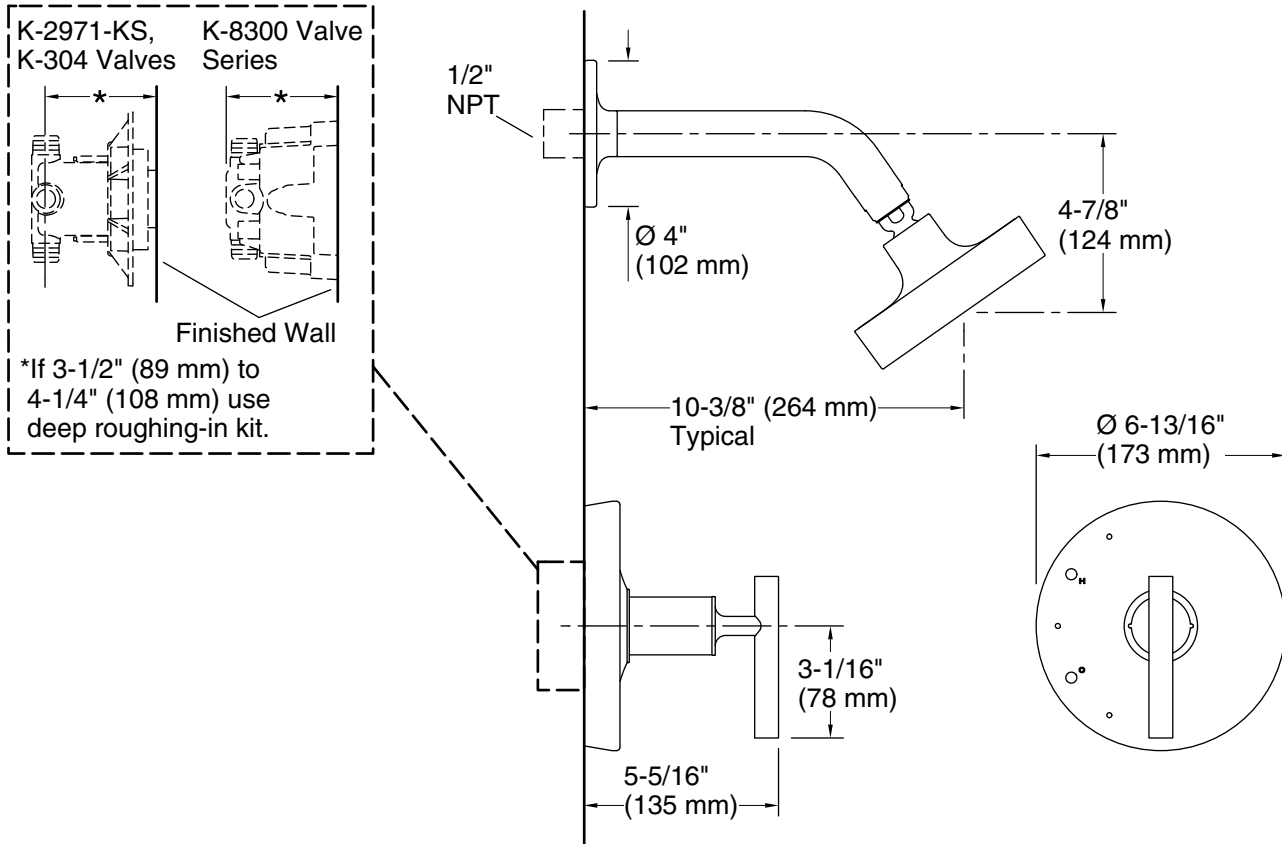

### Technical Information

All product dimensions are nominal.

Drain included: No

### Showerhead/Body Spray:

Rated maximum flow: 1.75 gal/min (6.6 l/min)

Pressure: 80 psi (5.5 bar)

### Notes

For use with automatic compensating valves rated at 1.6 gal/min (6.1 l/min) or less.

Install this product according to the installation instructions.

**NOTICE:** Risk of product damage. Long screws, for installing trim, can damage the K-2971-KS valve. Consult the trim installation guide to verify if the thin wall installation kit is needed.