

Features

- Lever handle
- Push-button diverter
- Completes Purist design solution with KOHLER fixtures and accessories

Material

- Brass

Required Products/Accessories

K-11748 Series Rite-Temp® Valves

Recommended Products/Accessories

K-23723 Faucet cleaner

Optional Products/Accessories

88526



ADA

CSA B651

OBC

Codes/Standards

ASME A112.18.1/CSA B125.1

ADA

ICC/ANSI A117.1

CSA B651









OBC

KOHLER® Faucet Lifetime Limited Warranty

See website for detailed warranty information.

Available Colors/Finishes

Color tiles intended for reference only.

Color	Code	Description
	CP	Polished Chrome
	SN	Vibrant® Polished Nickel
	AF	Vibrant® French Gold
	BN	Vibrant® Brushed Nickel
	BV	Vibrant® Brushed Bronze
	BL	Matte Black
	2MB	Vibrant® Brushed Moderne Brass
	RGD	Vibrant Rose Gold
	VHR	

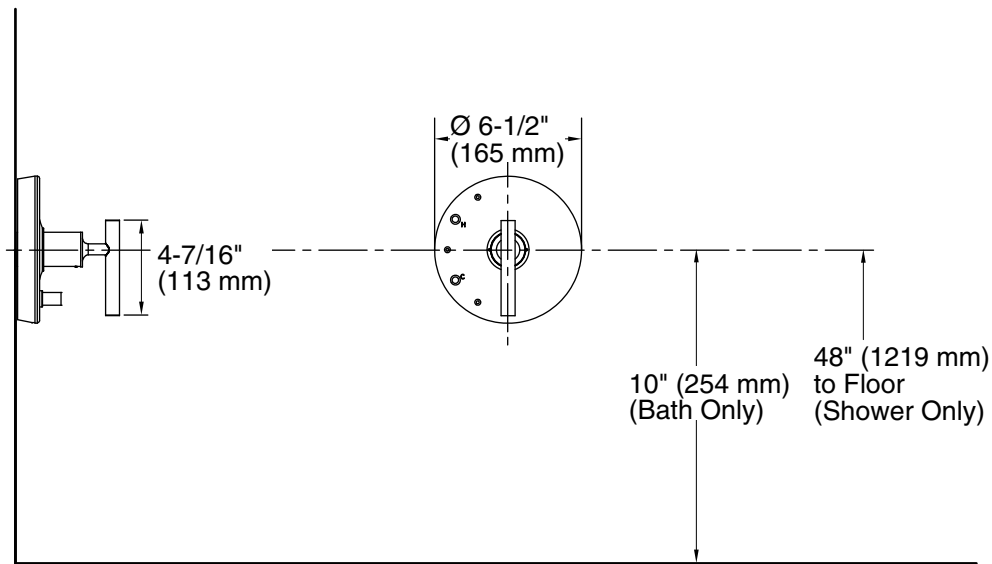

Technical Information

All product dimensions are nominal.

Drain included: No

Showerhead/Body Spray:

Rated maximum flow: 2.5 gal/min (9.5 l/min)

Notes

Install this product according to the installation guide.

Cap the shower outlet if deck-mount spout, diverter, or handshower is connected to the spout outlet.

ADA, OBC, CSA B651 compliant when installed to the specific requirements of these regulations.