

### Features

- Includes face plate with handle.
- Single handle controls flow to outlets.
- Supplied with ADA compliant metal lever handle.
- When used with K-728 Series MasterShower diverter valves, handle controls flow to two or three outlets individually or any two outlets at a time.
- When used with K-737 Series MasterShower diverter valves, handle controls flow to two or three outlets individually or only one outlet at a time.
- Valve (not supplied) can be configured on site for two or three outlet operation.
- 360 degree handle rotation with three-outlet operation.
- 120 degree handle rotation with two-outlet operation.
- Complements the Purist® faucet and accessory collections.

### Material

- Premium material construction with metal handle ensures reliability and durability.
- KOHLER finishes resist corrosion and tarnishing.

### Installation

- Trim set requires valve to complete installation (sold separately).
- Patented K-joint installation technology ensures consistent trim appearance, regardless of variability in valve rough-in.

### Recommended Products/Accessories

K-728-K 3/4" Two- or Three-Way Transfer Valve  
K-737-K 3/4" Two- or Three-Way Diverter Valve  
K-23723 Faucet cleaner



ADA

CSA B651

OBC

### Codes/Standards











ASME A112.18.1/CSA B125.1  
ADA  
ICC/ANSI A117.1  
CSA B651  
OBC

### KOHLER® Faucet Lifetime Limited Warranty

See website for detailed warranty information.

### Available Colors/Finishes

*Color tiles intended for reference only.*

Color	Code	Description
	CP	Polished Chrome
	SN	Vibrant® Polished Nickel
	AF	Vibrant® French Gold
	PGD	Vibrant® Moderne Polished Gold
	BGD	Vibrant® Moderne Brushed Gold
	G	Brushed Chrome
	BN	Vibrant® Brushed Nickel
	BV	Vibrant® Brushed Bronze
	BL	Matte Black
	RGD	Vibrant Rose Gold

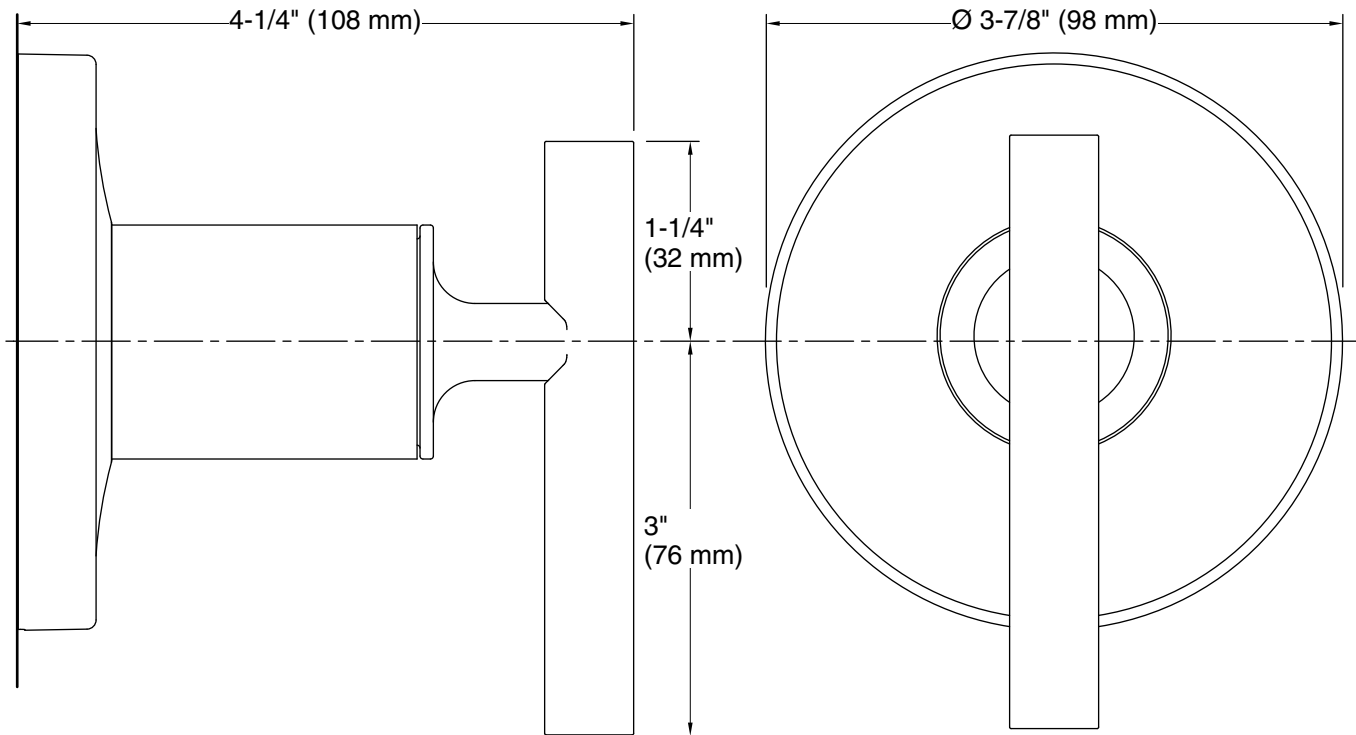

**Technical Information**

All product dimensions are nominal.

**Notes**

Install this product according to the installation instructions.

ADA, OBC, CSA B651 compliant when installed to the specific requirements of these regulations.