

Features

- Includes face plate with handle, bath spout, shower arm and flange.
- Single handle controls both on/off activation and temperature settings.
- Cross handle.
- Integrated push-button diverter.
- Includes non-diverter bath spout with 1/2" NPT connection.
- For use with any KOHLER showerhead (sold separately).
- Complements the Purist faucet and accessory collections.

Material

- Premium material construction with metal handle ensures reliability and durability.
- KOHLER finishes resist corrosion and tarnishing.

Installation

- Trim set requires valve to complete installation (sold separately).

Required Products/Accessories

K-11748 Series Rite-Temp® Valves

Recommended Products/Accessories

K-23723 Faucet cleaner



ADA

Codes/Standards







ASME A112.18.1/CSA B125.1
ADA

KOHLER® Faucet Lifetime Limited Warranty

See website for detailed warranty information.

Available Colors/Finishes

Color tiles intended for reference only.

Color	Code	Description
	CP	Polished Chrome
	SN	Vibrant® Polished Nickel
	BGD	Vibrant® Moderne Brushed Gold
	BN	Vibrant® Brushed Nickel
	BV	Vibrant® Brushed Bronze
	BL	Matte Black

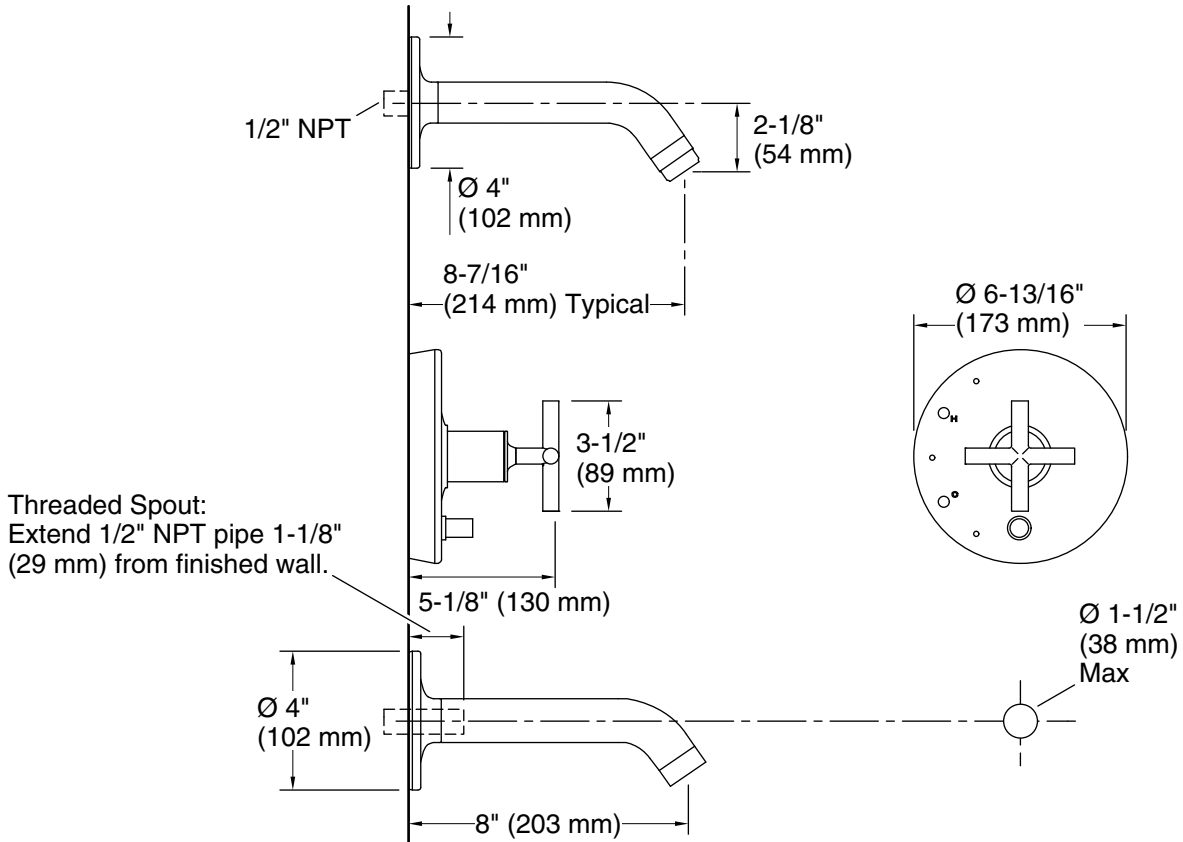

Technical Information

All product dimensions are nominal.

Notes

- Install this product according to the installation instructions.
- Avoid cross-flow conditions. Do not install shut-off device on either valve outlet.
- Cap the shower outlet if deck-mount spout, diverter, or handshower is connected to the spout outlet.
- ADA compliant when installed to the specific requirements of these regulations.