



Bardon™

High-efficiency urinal with Mach® Tripoint®
flushometer
K-PR4991-T2D

Features

- Fixture and touchless flushometer combination is engineered for optimal performance
- Washout urinal
- 0.5 gpf (1.9 lpf)
- 3/4" (19 mm) top spud
- Flush valve activation distance is factory-set
- No external flush volume adjustment ensures water conservation
- 24-hour automatic sentinel flush keeps trapway fresh
- Mechanical override enables flushometer to be used manually even during a power outage
- Chloramine and chlorine resistance on all rubber components exposed to waterway
- Locking stop cap provides protection against vandalism
- 125-micron filter protects internal components
- High back pressure vacuum breaker
- Powered by 1.5V AA lithium batteries
- For this combination, order K-4991-ET urinal and K-10UD00G20 flushometer

Material

- Vitreous china urinal
- Brass flush valve with durable Polished Chrome finish

Technology

- Electronic infrared sensor with Tripoint® technology for accurate activation
- Patented piston technology for superior flush volume accuracy

Water Conservation & Rebates

- This product can help a building earn Water Efficiency points in LEED® Green Building Rating System

Included Components

Additional Components:

- 2" outlet spud
- 3/4" inlet spud
- Hanger(s) (Qty 2)
- Strainer



ADA

CSA B651

OBC

Codes/Standards

ASME A112.18.1/CSA B125.1
ASME A112.19.2/CSA B45.1
ASSE 1037/ASME A112.1037/CSA B125.37
DOE - Energy Policy Act 1992
EPA WaterSense®
California Energy Commission (CEC)
ADA
ICC/ANSI A117.1
CSA B651
OBC

KOHLER® One-Year Limited Warranty

See website for detailed warranty information.

1-800-4KOHLER (1-800-456-4537)

Kohler Co. reserves the right to make revisions without notice to product specifications.

For the most current Specification Sheet, go to www.kohler.com.

1-8-2023 12:42 - US/CA

THE BOLD LOOK
OF **KOHLER**®

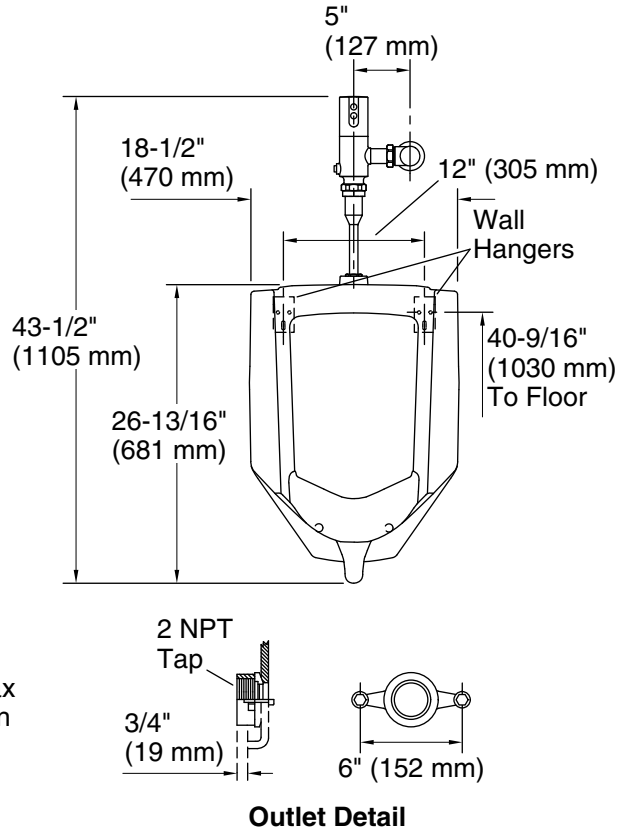
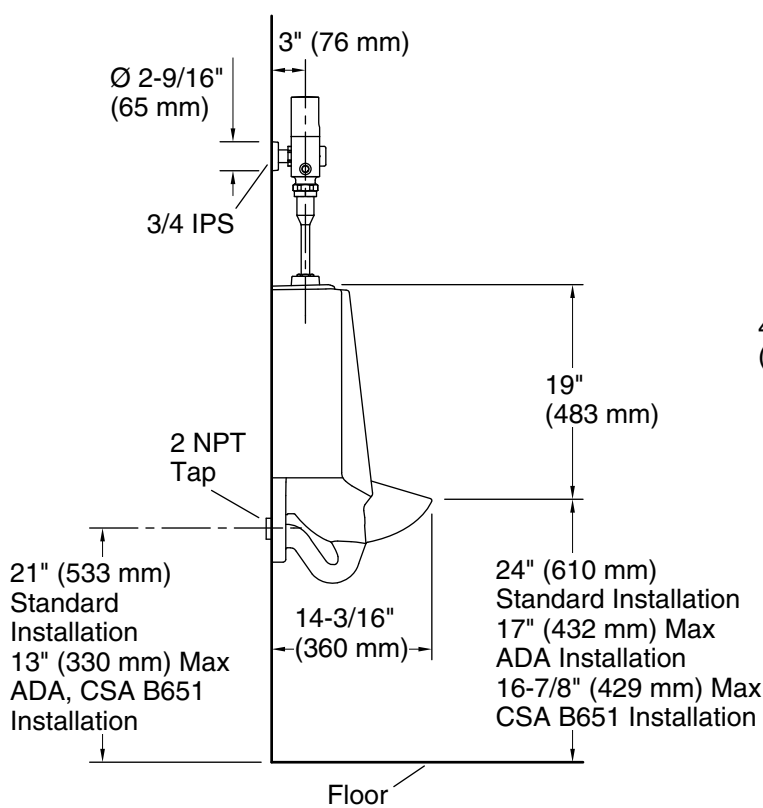

Technical Information

All product dimensions are nominal.

Flush outlet technology: Washout
 Spud size: 3/4, Outlet, Top

Pressure and Supply Requirements

Fixture pressure min 25 psi (172.4 kPa) (static):
 Fixture flow rate min: 25 gpm (94.6 lpm)
 Fixture pressure 80 psi (551.6 kPa) max (static):

Notes

Install this product according to the installation instructions.

ADA, OBC, CSA B651 compliant when installed to the specific requirements of these regulations.