

Features

- Low-threshold design for easy entry and exit.
- Covered drain with removable cover.
- Single threshold for alcove installation.
- Durable acrylic construction.
- Center drain.
- Coordinates with other products in the Archer collection.

Recommended Products/Accessories

K-9132 Shower Drain
 K-1733 9 kW Steam Generator
 K-702206-G54 Frameless Sliding Shower Door
 K-702206-G73 Frameless Sliding Shower Door
 K-702206-L Frameless Sliding Shower Door
 K-702207-L Frameless Sliding Shower Door
 K-702217-L Frameless Sliding Shower Door
 K-705705-L Frameless Pivot Shower Door
 K-705711-L Frameless Pivot Shower Door
 K-705717-L Frameless Pivot Shower Door
 K-705723-L Frameless Pivot Shower Door
 K-705729-L Frameless Pivot Shower Door
 K-705741-L Frameless Pivot Shower Door
 K-705810-L Semi-Frameless Pivot Shower Door
 K-705811-L Semi-Frameless Pivot Shower Door
 K-705824-L Semi-Frameless Pivot Shower Door
 K-705825-L Semi-Frameless Pivot Shower Door
 K-706009-D3 Frameless Sliding Shower Door
 K-706009-L Frameless Sliding Shower Door
 K-706012-L Frameless Sliding Shower Door
 K-706013-L Frameless Sliding Shower Door
 K-706015-D3 Frameless Sliding Shower Door
 K-706015-L Frameless Sliding Shower Door
 K-706019-L Frameless Sliding Shower Door



Codes/Standards











ASME A112.19.1/CSA B45.2
 CSA B45.5/IAPMO Z124
 ASTM E162
 ASTM E662

KOHLER® Plastic Baths and Receptors Lifetime Limited Warranty

See website for detailed warranty information.

Available Colors/Finishes

Color tiles intended for reference only.

Color	Code	Description
	0	White
	96	Biscuit
	47	Almond
	NY	Dune
	95	Ice™ Grey
	G9	Sandbar
	33	Mexican Sand™
	K4	Cashmere
	58	Thunder™ Grey
	7	Black Black™

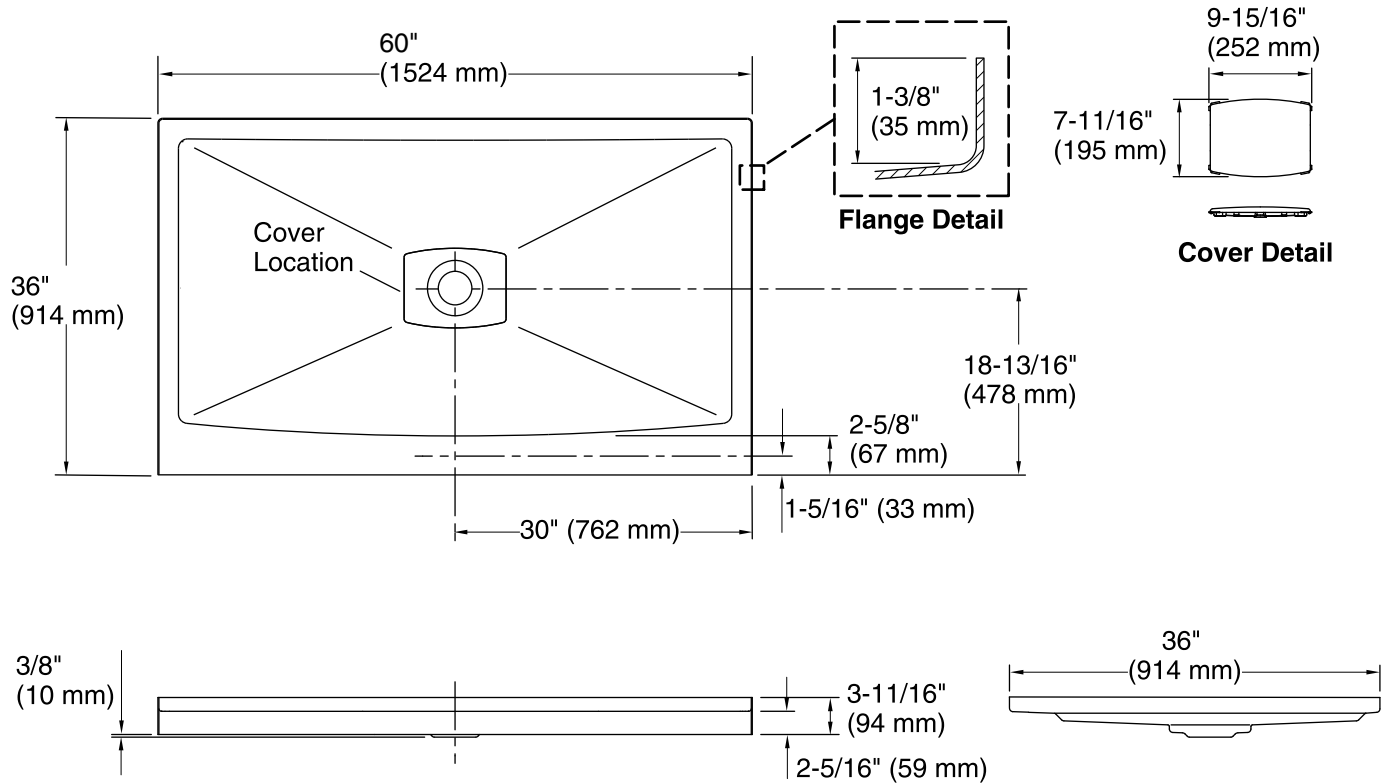

Technical Information

All product dimensions are nominal.

Installation:	Three-wall alcove
Drain location:	Center
Weight:	52 lbs (23.6 kg)
Minimum floor load:	17 lbs/ft ² (83 kg/m ²)

Notes

- Measure your actual product for rough-in details.
- Install this product according to the installation instructions.
- Shimming may be required to level the fixture.
- Shimming may be required between the stud frame and the fixture.
- Stud opening tolerance is + 1/4" (6 mm), - 0" (0 mm).