

### Features

- Removable round-shaped grid plate.
- Reversible collar to accommodate a variety of tile thicknesses.
- 2" and 3" PVC connection.

### Material

- Brass and PVC construction.
- KOHLER finishes resist corrosion and tarnishing.

### Installation

- Through-the-floor tile-in installation.



### Codes/Standards















ASME A112.18.2/CSA B125.2

### KOHLER® One-Year Limited Warranty

See website for detailed warranty information.

### Available Colors/Finishes

*Color tiles intended for reference only.*

Color	Code	Description
	CP	Polished Chrome
	SN	Vibrant® Polished Nickel
	AF	Vibrant® French Gold
	PB	Vibrant® Polished Brass
	BGD	Vibrant® Moderne Brushed Gold
	G	Brushed Chrome
	BN	Vibrant® Brushed Nickel
	BV	Vibrant® Brushed Bronze
	BRZ	Oil-Rubbed Bronze
	2BZ	Oil-Rubbed Bronze
	BL	Matte Black
	RGD	Vibrant Rose Gold
	TT	Titanium
	VNT	Vintage Nickel

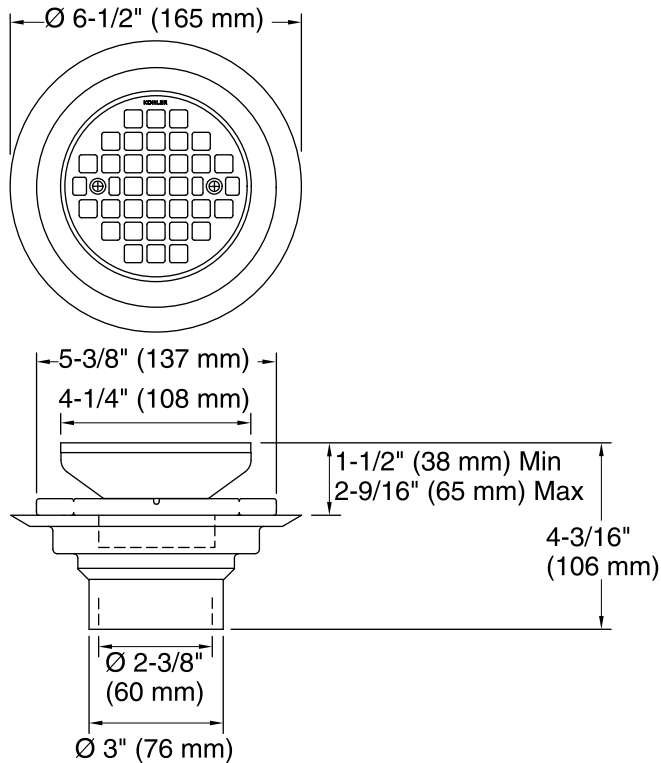

**Collar with Threads Facing Down**

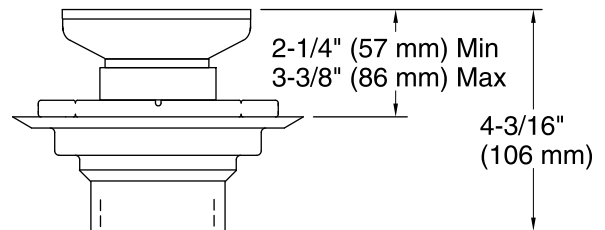

**Collar with Threads Facing Up**

**Technical Information**

All product dimensions are nominal.

**Notes**

Install this product according to the installation instructions.