

Features

- 8 hydromassage jets can be individually adjusted for water flow and direction.
- Variable-speed pump for adjusting massage intensity.
- 8 effervescence ports deliver gentle, caressing bubbles.
- Chromatherapy lighting allows you to select a preferred color scheme to suit your mood.
- Built-in heater.
- Electronic keypad.
- Remote control.
- Spacious design accommodates up to two bathers.
- Safeguard® slip-resistant surface on bath floor.
- End drain.
- Under-mountable

Material

- KOHLER® enameled cast iron.

Hydrotherapy

- Whirlpool
- Effervescence
- Chromatherapy

Installation

- Drop-in or under-mount.

Additional Hydrotherapy Options

- Soaking Bath - K-855-0
- Whirlpool - K-856-H2
- Whirlpool Massage Package - K-856-M
- Effervescence Relax Package - K-856-CT
- Effervescence Spa Package - K-856-AH
- Spa Package + Massage Package - K-856-V

Required Products/Accessories

K-7147-AF 1-1/2" Contoured Pop-up Drain

Recommended Products/Accessories

K-1491 Bath/Whirlpool Pillow
K-1601 Bath/Whirlpool Footstop
K-587 Under-Mount Installation Kit
K-1703 Whirlpool Remote Control
K-9498 3" Keypad Trim
K-9698 Flexjet® Whirlpool Trim Kit
K-1179 Vinyl Tiling-in Bead



Codes/Standards

ASME A112.19.1/CSA B45.2
ASME A112.19.7/CSA B45.10
ASTM F462
UL 1795
CSA C22.2 No. 218.2









KOHLER® Enameled Cast Iron Bath and Shower Base Lifetime Limited Warranty

KOHLER® Hydrotherapy Components Five-Year Limited Warranty

See website for detailed warranty information.

Available Colors/Finishes

Color tiles intended for reference only.

Color	Code	Description
	0	White
	96	Biscuit
	47	Almond
	NY	Dune
	95	Ice™ Grey
	33	Mexican Sand™
	58	Thunder™ Grey
	7	Black Black™

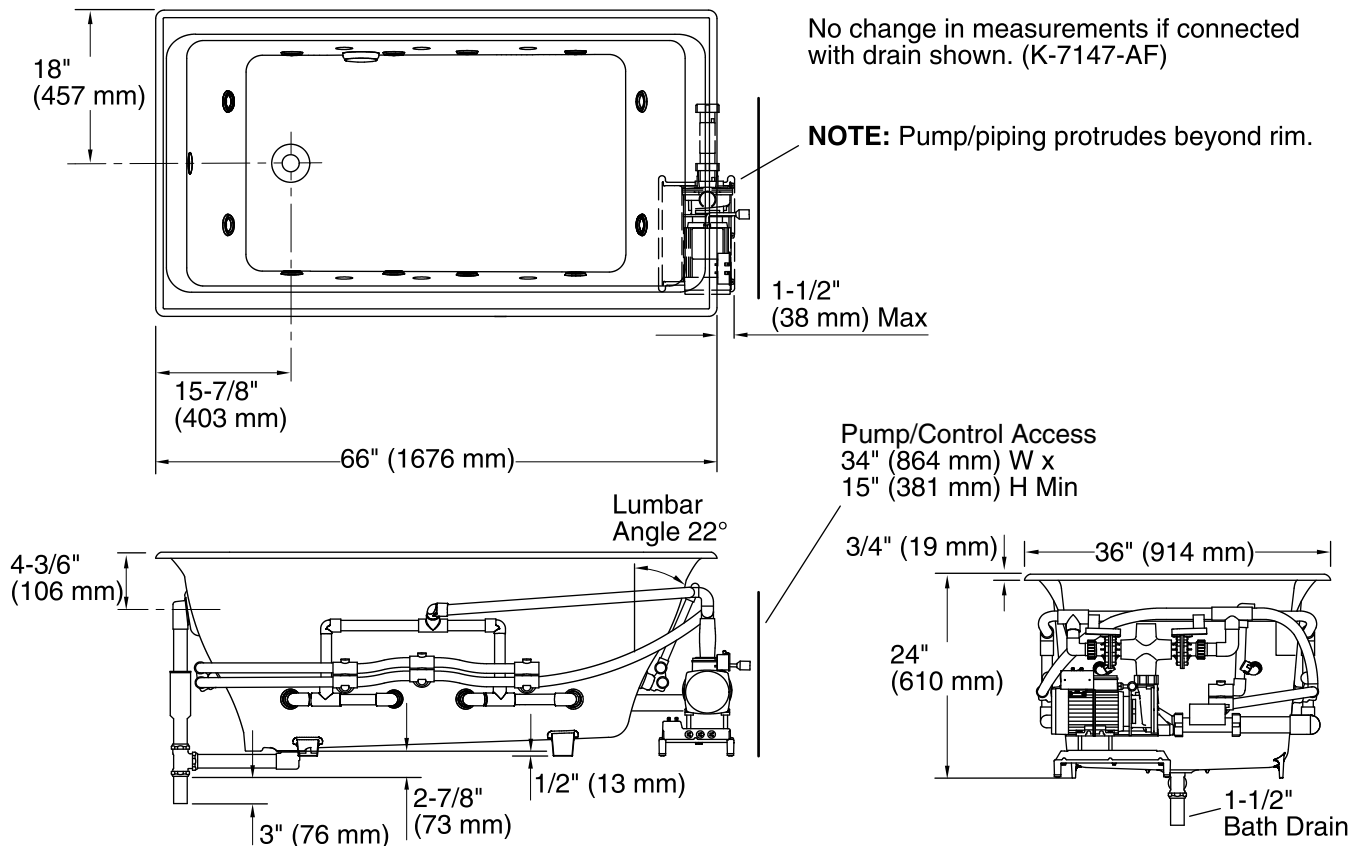

Required Electrical Service

One dedicated circuit required, protected with Class A Ground-Fault Circuit-Interrupter (GFCI). Outside North America, this device may be known as a Residual Current Device (RCD).

Pump, Heater: 240 V, 20 A, 50/60 Hz

Technical Information

All product dimensions are nominal.

Installation:	Drop-in, Under-mount
Drain location:	End
Basin area, bottom:	45" x 25" (1143 mm x 635 mm)
Basin area, top:	58" x 29" (1473 mm x 737 mm)
Weight:	510 lbs (231.3 kg)
Minimum floor load:	86 lbs/ft ² (419.9 kg/m ²)
Water depth:	19-1/2" (495 mm)
Water capacity:	105 gal (397.5 L)
Cutout:	Drop-in, 65-1/2" x 35-1/2" (1664 mm x 902 mm)
Template:	Under-mount, K-587, required, not included
Electrical component rating:	Pump: 240 V, 11 A, 50/60 Hz Heater: 240 V, 6 A, 1500 W

Notes

Measure your actual product for rough-in details. Install this product according to the installation instructions.

The hot water supply should be 70% of the capacity of the bath or greater. Installations will vary.

Kit is required for under-mount installations (sold separately).

Cast iron whirlpools are extremely heavy, making some drop-in installations difficult. Splitting the deck/surround is recommended if installing into a deck.