

Features

- MasterClean™ sprayface features an easy-to-clean surface that withstands mineral buildup.
- Katalyst® air-induction technology maximizes the air/water mix for a powerful, even flow.
- 1/2" NPT connection.
- Single-function 27-nozzle body spray delivers a stimulating spray.
- Fully adjustable sprayface pivots for targeted hydromassage.
- Low-profile design complements any decor.
- 2.0 gpm (7.6 lpm) maximum flow rate at 80 psi (5.5 bar).
- 1/2" NPT connection.

Material

- KOHLER finishes resist corrosion and tarnishing.
- Premium metal construction for durability and reliability.

Installation

- Ceiling- or wall-mount.

Recommended Products/Accessories

K-23723 Faucet cleaner



Codes/Standards











ASME A112.18.1/CSA B125.1
DOE - Energy Policy Act 1992

KOHLER® Faucet Lifetime Limited Warranty

See website for detailed warranty information.

Available Colors/Finishes

Color tiles intended for reference only.

Color	Code	Description
	CP	Polished Chrome
	SN	Vibrant® Polished Nickel
	AF	Vibrant® French Gold
	BN	Vibrant® Brushed Nickel
	BV	Vibrant® Brushed Bronze
	2BZ	Oil-Rubbed Bronze
	BL	Matte Black
	2MB	Vibrant® Brushed Moderne Brass
	TT	Vibrant Titanium
	VNT	Vintage Nickel

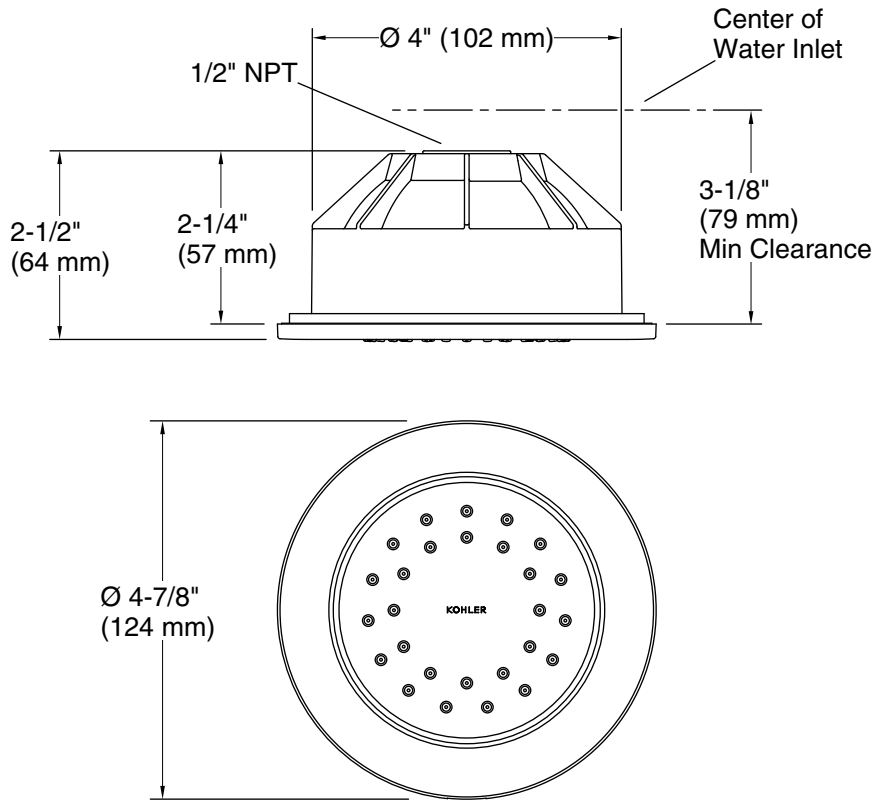

Technical Information

All product dimensions are nominal.

Notes

Install this product according to the installation instructions.