

Features

- Intended to replace existing overflow cover and stopper/drain, flange/toggle linkage
- Toe-tap component installs on most drain bodies with 1-1/2"-11 1/2 NPSM thread
- For KOHLER drains K-7160-AF, K-7160-TF, K-7161-AF, K-7193
- Metal construction

Recommended Products/Accessories

K-7193 Bath Drain
K-23723 Faucet cleaner



Codes/Standards









ASME A112.18.2/CSA B125.2

KOHLER® Faucet Lifetime Limited Warranty

See website for detailed warranty information.

Available Colors/Finishes

Color tiles intended for reference only.

Color	Code	Description
	CP	Polished Chrome
	SN	Vibrant® Polished Nickel
	AF	Vibrant® French Gold
	BN	Vibrant® Brushed Nickel
	BV	Vibrant® Brushed Bronze
	2BZ	Oil-Rubbed Bronze
	BL	Matte Black
	2MB	Vibrant® Brushed Moderne Brass
	TT	Vibrant Titanium

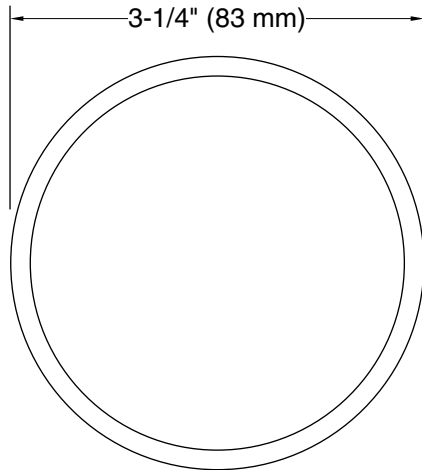

Overflow Cover

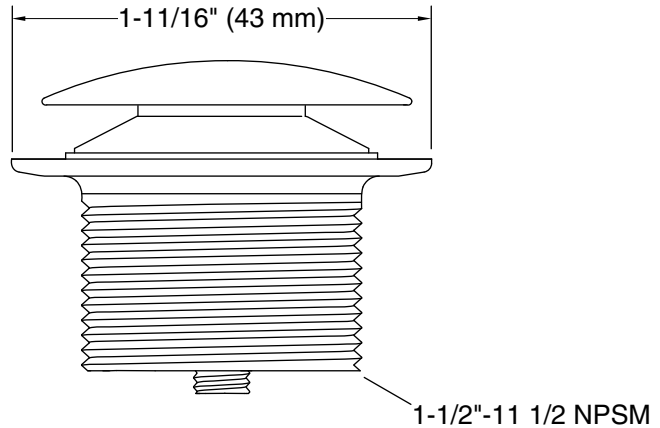

Toe-Tap

Technical Information

All product dimensions are nominal.

Notes

Install this product according to the installation instructions.

IMPORTANT! This installation should be performed by a qualified plumber.

IMPORTANT! Provide access to the back of the bath. Removing the existing overflow cover may effect the seal. Inspect the back of the bath for leaks after completing this retrofit installation.