

Features

- Column lets you customize your shower with a showerhead and handshower.
- Arched shower arm makes it possible to install with low ceiling heights.
- Slidebar bracket allows you to adjust height and angle of the handshower.
- Diverter at the base of the column makes for easy toggling between the handshower and showerhead.
- Rainhead, handshower, and hose sold separately to allow for customized components.

Material

- KOHLER finishes resist corrosion and tarnishing.
- Premium metal construction.

Installation

- Wall-mount shower only installation.
- Installs in less than 60 minutes without changes to in-wall plumbing (subject to condition of existing installation).
- Includes an adapter that will fit with most installations but may require 1194630, 1187917, or 1194302.

Adapters, Rough-in and Extension Kits

1187917 Range: 0" (0 mm) - 1-3/8" (35 mm)

1194630 Range: 2-7/8" (73 mm) - 4" (102 mm)

Recommended Products/Accessories

- 1194302 Large Escutcheon/Mounting Collar Kit
- K-13688 Contemporary Round Rain Showerhead
- K-13689 Contemporary Round Katalyst® 2.5 gpm rainhead
- K-13692 Traditional Round Rain Showerhead
- K-13695 Contemporary Square Rain Showerhead

Included Components

Additional Components:

- Column
- Diverter
- Handshower bracket
- Hose
- Slidebar

Installed component/s: Column, Bracket, Hose, and Slidebar.



ADA CSA B651 OBC

Codes/Standards







ASME A112.18.1/CSA B125.1
ADA
ICC/ANSI A117.1
CSA B651
OBC

KOHLER® Faucet Lifetime Limited Warranty

See website for detailed warranty information.

Available Colors/Finishes

Color tiles intended for reference only.

Color	Code	Description
	CP	Polished Chrome
	SN	Vibrant® Polished Nickel
	BN	Vibrant® Brushed Nickel
	BV	Vibrant® Brushed Bronze
	2BZ	Oil-Rubbed Bronze
	TT	Titanium

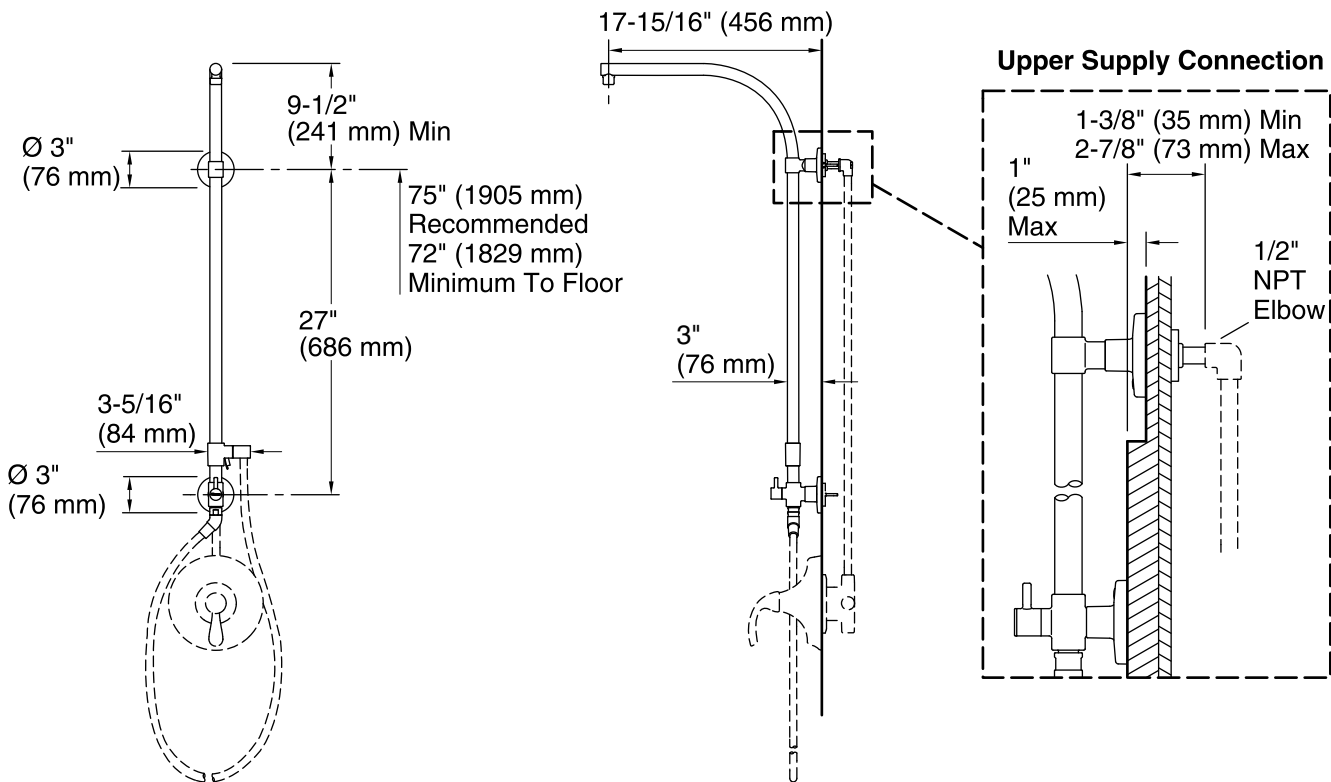

NOTE: Valve trim and hose illustrated for dimensioning only, not included in the product.

Technical Information

All product dimensions are nominal.

Drain included: No

Notes

Install this product according to the installation guide.

Order deep roughing-in kit if the distance from the elbow to the finished wall surface is between 2-7/8" (73 mm) to 4" (102 mm).

Order shallow roughing-in kit if the distance from the elbow to the finished wall surface is less than 1-3/8" (35 mm).

Order large escutcheon/mounting collar kit if the supply connection hole diameter is between 1-1/4" (32mm) to 2-1/4" (57 mm).

A 3" (76 mm) escutcheon/mounting collar is supplied to fit a 1" (25 mm) to 1-1/4" (32 mm) supply connection hole diameter.

ADA, OBC, CSA B651 compliant when installed to the specific requirements of these regulations.