

250.1950 | Three Hole Wall Mount Faucet

SPECIFICATIONS:

- Solid Brass construction - includes valve (WLM.1900)
- Three Hole Installation
- 1.2 GPM Flow Rate @ 60 PSI
- Extension Available - 250.1950E**

STANDARDS:

- ASME A112.18.1 / CSA B125.1, NSF-61

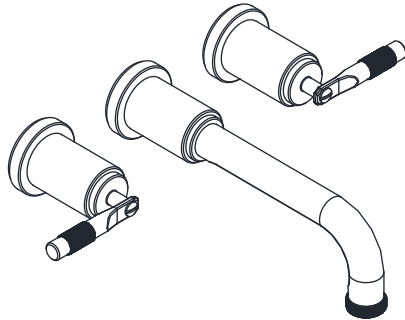

LowFlow Capable



Legislation Compliance



Low Lead Compliant



ZeroDrip Technology



Technical Diagram

