

Ecostat Classic
Pressure Balance Trim with Diverter, Round
 Finishes : **chrome** Part no. : **04449000**



Description

Features

- Outlets may be operated simultaneously
- Flow: 4.5 GPM (17 L/Min)
- Temperature and on/off control for 2 outlets

Item details

List Price \$ 324.00

Compliance



Product image



Scale drawing

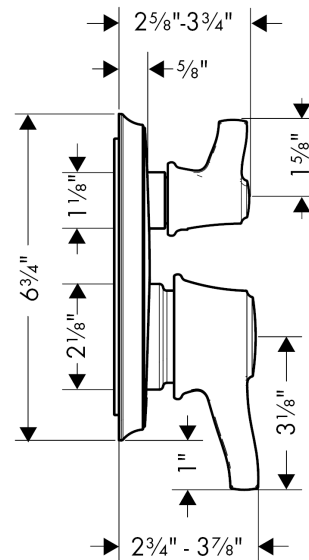

Ecostat Classic
Pressure Balance Trim with Diverter, Round
 Finishes : **chrome** Part no. : **04449000**



Exploded drawing

Year of production: >04/12

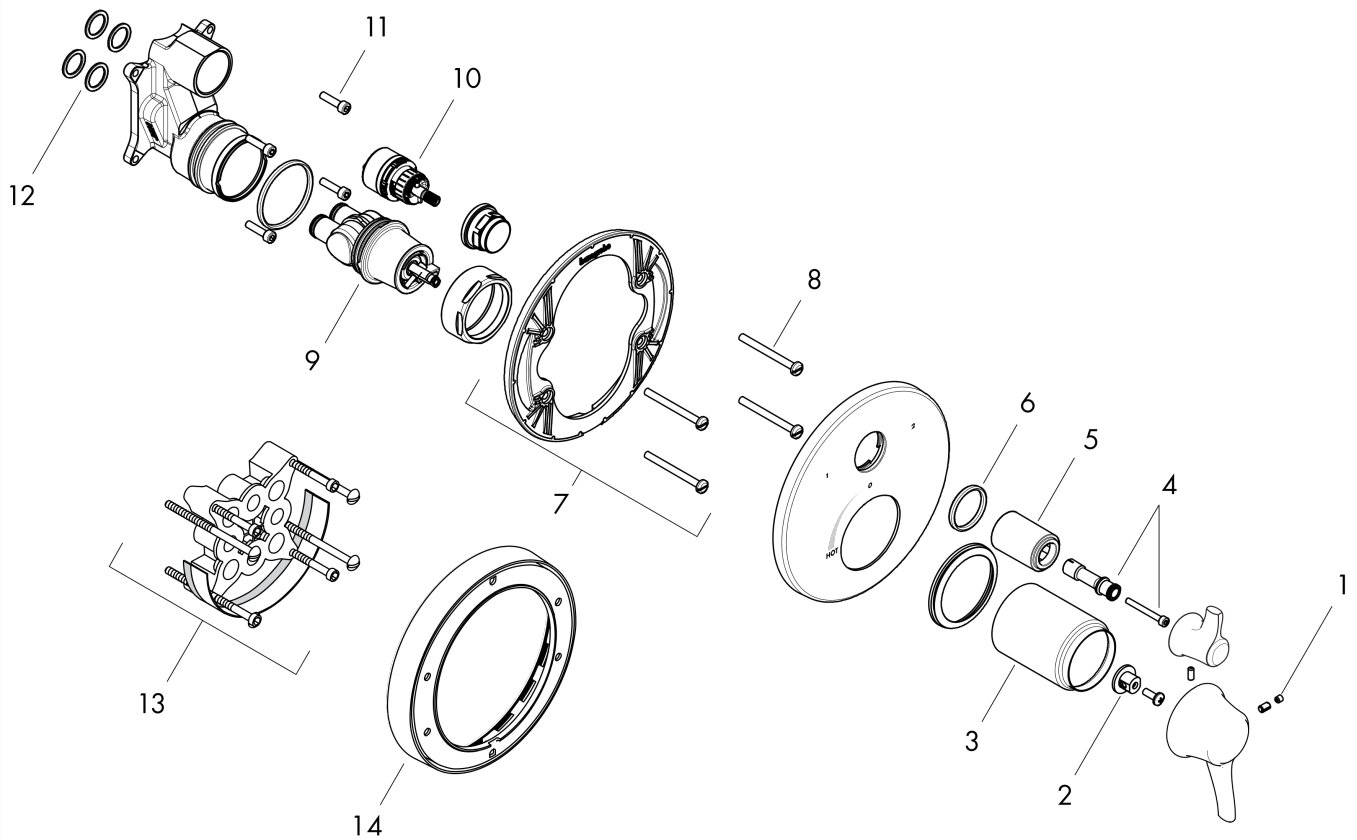

Ecostat Classic
Pressure Balance Trim with Diverter, Round
 Finishes : **chrome** Part no. : **04449000**



Spare parts list

Year of production: >04/12

Pos.	Description	Part no.	Price	PU
1	screw cover	95181000	-	1
2	adapter for handle	92756000	-	1
3	sleeve	88765000	-	1
4	adapter for handle	88772000	-	1
5	sleeve	95253000	-	1
6	O-ring 29x3	98371000	-	1
7	holder for escutcheon	98793000	-	1
8	set of fixing screws	96454000	-	1
9	cartridge, assy	88727000	-	1
10	shut off unit with selector	98283000	-	1
11	set of screws	96525000	-	1
12	O-ring 16x2	98133000	-	1
13	extension 25 mm	13595000	-	1
14	extension 22 mm (Ø 170 mm)	13596000	-	1
a	base body	01850181	-	1
b	set of fixing screws	97747000	-	1