

## Wall-mounted Lavatory Faucet Rough-In Valve Model : MP4200.RI

### Features:

- Solid brass construction
- 1/2 NPT Female Connection

### Standards:

- CSA B125.1
- NSF/ANSI standard 61
- NSF/ANSI standard 372
- ASME A112.18.1

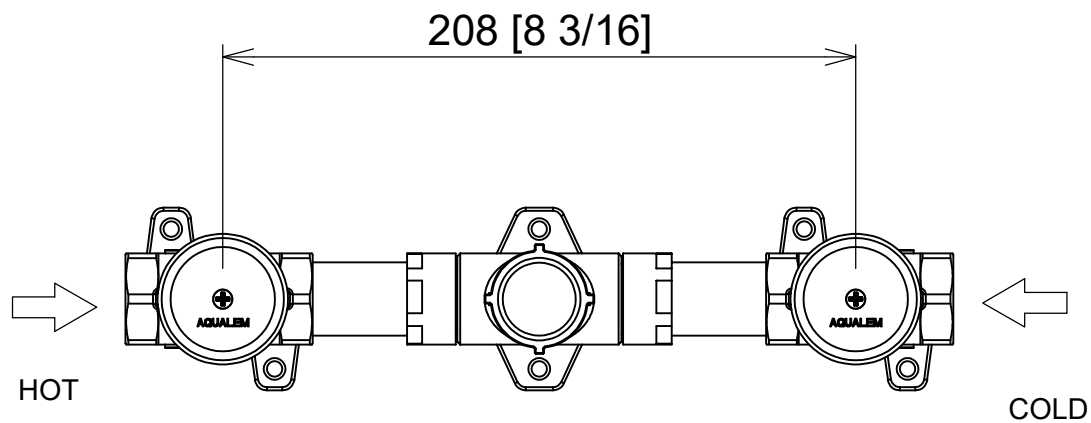
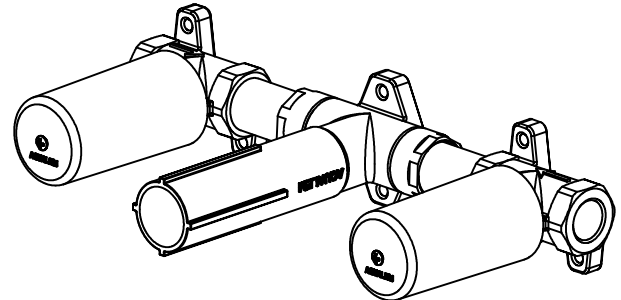

Finished wall must be between Max. ~ Min.

